



QAX95.4



QAX96.4



QAX97.4



QAX98.4

Wireless and battery-less room units with EnOcean interface

QAX95.4
QAX96.4
QAX97.4
QAX98.4

Usable with devices from the following ranges:

- RXC (together with gateway EnOcean/LONWORKS, RXZ95.1/LON)
- RXB (together with gateway EnOcean/KNX, RXZ97.1/KNX)
- Devices with KNX or LONWORKS® communications

- Room temperature acquisition
- Room temperature setpoint adjustment *
- Freely-programmable button *
- Step switch *
- Powered by solar cell
- Used together with suitable gateway

* See Table on page 3

Specially suited for

- Renovation projects (old buildings, museums, churches, historical buildings, etc.).
- Rooms where wall reworking is difficult or even impossible (sandstone, glass, metal)
- Spaces requiring adjustable room division (open plan offices, museums, TV studios)
- Rooms with flexible furnishing or frequently changing decor
- System extensions

Use

The wireless room units are used to acquire the room temperature and, with the exception of QAX95.4, adjust the room temperature setpoint.

Wireless range in building is ca. 30 m.

For operation, the connection to the gateway must first be set up. See data sheet N1661 (Gateway EnOcean/LonWorks) or N1662 (Gateway EnOcean/KNX).

Typical application (example with additional third-party components)

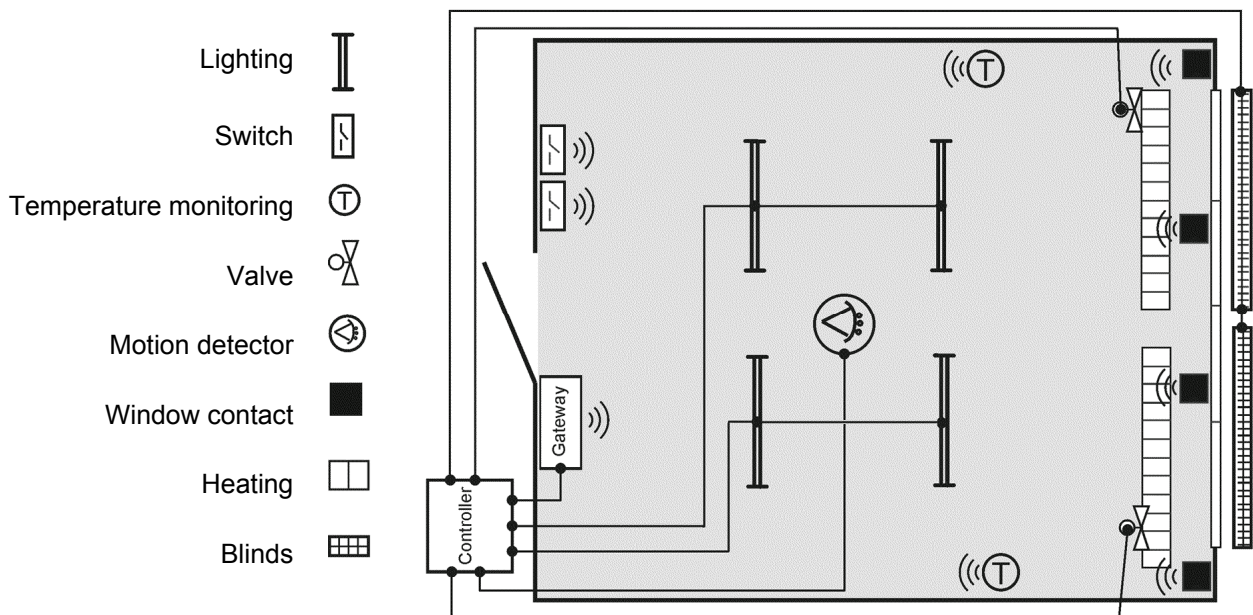

Type summary / Ordering

| Type | Stock number | Name | Description |
|---------|--------------|--|---|
| QAX95.4 | S55623-H104 | Wireless and battery-less room unit with EnOcean interface | Without operating elements (temperature sensor only) |
| QAX96.4 | S55623-H105 | Wireless and battery-less room unit with EnOcean interface | With setpoint adjustment unit |
| QAX97.4 | S55623-H106 | Wireless and battery-less room unit with EnOcean interface | With setpoint adjustment unit, freely programmable button and switch (2 stages) |
| QAX98.4 | S55623-H107 | Wireless and battery-less room unit with EnOcean interface | With setpoint adjustment unit, freely programmable button and switch (5 stages) |

Equipment combinations

Wireless room units together with a gateway (EnOcean/LONWORKS or EnOcean / KNX) can be used with all controllers on a LONWORKS or KNX network (e.g. DESIGO RX).

EnOcean gateways

| Type | Stock number | Name | Data sheet |
|-------------|--------------|--------------------------|------------|
| RXZ95.1/LON | S55842-Z100 | Gateway EnOcean/LONWORKS | CM2N1661 |
| RXZ97.1/KNX | S55842-Z101 | Gateway EnOcean/KNX | CM2N1662 |

Design

The devices contain an upper and lower housing part (screwed on). They can be snapped onto a mounting plate. All parts are made from plastic.

Freely-programmable button (QAX97.4 or QAX98.4)

Solar cell

Rotary knobs (QAX97.4 or QAX98.4)

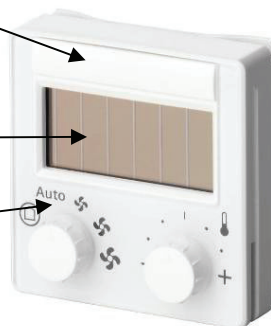

The learning button to connect to a gateway is located on the rear of the device.

The devices are supplied with the following accessories:

- Mounting plate
- Adhesive pad
- Frame (5TG2551-0 DELTA LINE, TITANIUM WHITE FRAME, 1FOLD)



Adhesive pad

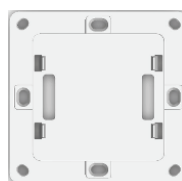

Mounting plate

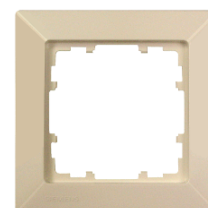

Frame



Caution!

- Only authorized personnel may connect and service the device.
- The device is designed for mounting in closed, dry, and bright rooms.
- The device features an integrated antenna. Metal walls or furniture may not interfere with the radio signal.
- Do not mount on a metallic surface, as this interferes with radio signal transmission. Minimum distance: 20 mm.
- If the device does not work, check first the mounting location and make sure the solar cell is exposed to sufficient light.

The device may not work as desired even if all installation notes are adhered to. Other signal sources may interfere with the radio signal used by this device. In addition, construction materials (concrete wall, metal wall, metal cabinets, metal shelves etc.) may seriously affect signal range.

Mounting location

Mount the device so that it can acquire median room temperature:

- Avoid drafts and do not mount close to doors and windows.
- Avoid heat sources.
- -Choose a bright location on an interior wall.

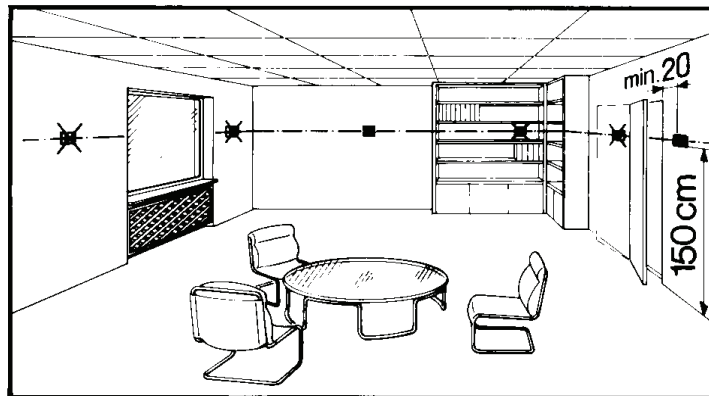

If the reference room contains thermostatic radiator valves, make sure they are set to maximum flow.

Mounting

You do not need to open the device for mounting.

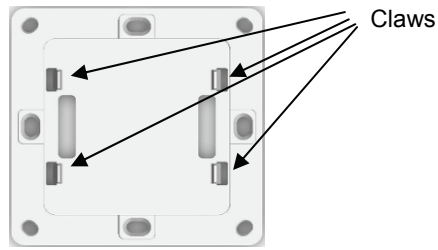

Mounting plate



Frame

Wall mounting

The mounting plate is asymmetric! Make sure the claws are located on the sides.

- Attach the mounting plate to the wall.
- Place the frame on top.
- The sensor can now easily snapped onto the mounting plate claws.

Mounting on glass surfaces

An adhesive pad (71 x 71 mm) is provided for mounting on glass surfaces. In addition to secure placing, this ensures visual protection for the device rear.

- Place the pad at the desired location.
- Remove the protective film and press down the pad inside out. This prevents air bubbles that later will be visible on the glass.
- Pull off the second protective film and firmly press down the entire room device (including mounting plate and frame) on the pad.



Check the conditions for correct operation **prior** to attaching the adhesive pad. Removing the adhesive pad is difficult and time-consuming.

List of usable frames

A list of usable frames is available on the intranet at:

https://workspace.sbt.siemens.com/content/00001062/intranet/RA/supplier_for_qax84or9x_4.doc

You can also use frames from various other manufacturers (clarify suitability beforehand).

Note Remove the springs on the device rear when combined with Feller frames.

Function

The room device determines the current room temperature and rotary knob position and transmits them via radio interface as soon as the energy store is sufficiently charged via the solar cell.

A receiver (gateway) receives the data telegrams and routes them to a control unit.

This type of cooperation requires that the receiver "trained" the sender. See data sheet N1661 (Gateway EnOcean/LonWorks) or N1662 (Gateway EnOcean/KNX).

Current room unit data are sent only every ca. 16 minutes to consume as little energy as possible. However, this signal, a so-called presence signal, is always sent. In addition, some events (change of measured values past a significant amount) are sent at a maximum delay of ca. 2 minutes. Pressing the programming button or the freely programmable button immediately triggers sending. For details, see the technical data "Frequency of transmission".





The room unit stops transmitting if the energy store is not charged sufficiently and/or the battery is empty.

100% functionality cannot be guaranteed under all circumstances. There are simply too many possible sources of interference, both legal and illegal, impacting range tremendously. This includes radio applications using the same frequency for transmission, e.g. other control systems with wireless connection. In addition, reflection based on room design or interior décor impacts signal quality and transmission security.

Operating elements

The devices use EnOcean profile EEP 07-10-01 for communications.

- The rotary knobs allow for choosing the controller's operating mode similar to a function for presence.
- The QAX98.4 allows for using the step switch to locally override the fan speeds and fan coil application operating modes.

| Type | Position | Fan control ¹⁾ | Operating mode ¹⁾ |
|--|---|-------------------------------------|---|
| <input checked="" type="checkbox"/> QAX97.4 <input checked="" type="checkbox"/> QAX98.4 |  | Automatic fan control by controller | The controller uses setpoints for reduced operation (room not occupied, night) |
| <input checked="" type="checkbox"/> | <input checked="" type="checkbox"/> Auto | Automatic fan control by controller | The controller uses Comfort mode (room occupied) |
| | <input type="checkbox"/>  | Manual | Fan speed 1 |
| | <input checked="" type="checkbox"/>  | Manual | Fan speed 2 |
| | <input type="checkbox"/>  | Manual | Fan speed 3 |

1) See the application description of the corresponding controller range for detailed function descriptions

- The function of the freely programmable button can be parameterized (see data sheets for the gateways).

Lighting conditions at mounting location

For guaranteed operation (without battery), at least 200 lux illuminance must be present for at least 3 to 4 hours daily. Avoid direct exposure to the sun, as this results in fault temperature readings. Avoid also shading by furniture as well as mounting in wall recesses without sufficient lighting.

| | |
|---|--------------------------|
| Startup time at empty energy store: | Ca. 1 min. at 400 lx |
| Illumination time required to charge the empty energy store for 14 hours operation in total darkness: | Ca. 6 h at 400 lx 1), 3) |
| Illumination time to recharge a working energy store for 14 hours operation in total darkness: | Ca. 2 h at 200 lx 1), 3) |
| Maximum operating time at 100% charge and total darkness: | Ca. 4 days |

- 1) Sending a radio signal ca. every 16 minutes (average).
- 2) Energy store charged at 1000 lx for 12 hours. A radio signal is sent every 16 minutes (average).
- 3) Typical value depending on storage time in darkness.

As brightness is hard to evaluate, we recommend control measurements using a device to measure illuminance.

Note For more information on lighting, see the installation manual DESIGO TRA, CM111043 (end of 2011).

Battery operation

Normally, ambient light suffices to charge the energy store required to operate the room unit. If, however, lighting conditions at the mounting location are insufficient to meet guide values, insert a battery in the battery holder. This ensures device operation even under unfavorable lighting conditions.

Use a lithium button cell battery (type CR2032).

This type of battery is common and easily available at electrical supply shops etc. The battery life can be up to 5 years dependent on how frequently data is sent. The battery will be emptied sooner if the device is operated in total darkness and radio telegrams are transmitted frequently.

Battery-supported operation is neither necessary nor recommended if there is sufficient light!

Insert the battery

- No need to open the device to insert the battery.
- Place the device on a flat surface.
- Insert the battery with the plus sign on top.
- The transmitter is ready for operation immediately following battery insertion.

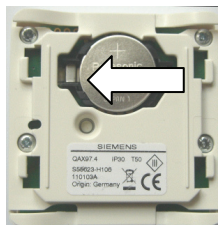

Push battery under claws on side

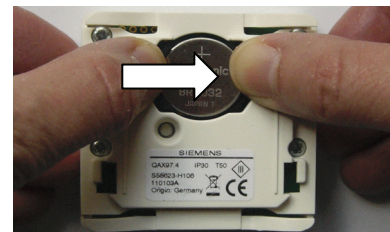

Press down on other side

Remove the battery

Use a screwdriver no. 2 to remove the battery. Carefully insert the screwdriver between battery and battery holder contact and lift up the battery.



- Notes
- Careless handling of the battery holder damages the holder. Proper and secure contacting of the battery may no longer be possible.
 - Do not try to remove the battery with your fingers. This may damage the battery holder and its attachment on the circuit board. Make sure you do not damage neighboring parts.
 - Dispose of the battery as indicated under local regulations.

General information on "radio signals"

In Europe, room units use frequency 868.3 MHz reserved for this purpose. This frequency may be used for various applications (ISM) with some limitations.

Use outside of Europe: Make sure this radio frequency is reserved for this type of device.

If radio signals on this frequency overlap and interfere, data transmission from a room unit to a receiver module may temporarily be impaired. The distance of sender and receiver to various interference sources (e.g. audio/video systems, computer) should at least be 50 cm.



Caution!

Check sensitive medical devices using this frequency range in a case-by-case basis.

The technical data section lists the standards adhered to by these devices.

Note For more information on radio signals, see the installation manual DESIGO TRA, CM111043 (from the end of 2011).

For operation, the connection to the gateway must first be set up. See data sheet N1661 (Gateway EnOcean / LonWorks) or N1662 (Gateway EnOcean / KNX).

Commissioning

Send "Init" telegrams

The LEARN button is located on the lower section of the housing below the battery. Press this button to create and immediately send a complete learning telegram. The current switching status of LEARN – pressed – is also transmitted.

If the corresponding receiver is being configured, the information helps assign a specific output channel to the sender.

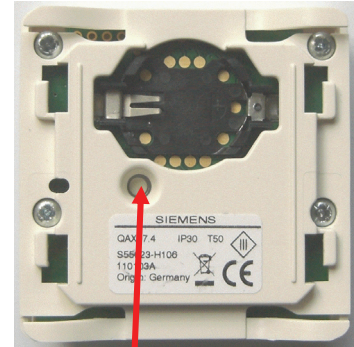

LEARN button

This procedure is referred to as "learning". A normal telegram does not initiate this procedure.

Repeat the procedure if you want to assign **several output channels** to one sender.

Simple function check

The LEARN button allows for a simple function and range test. **Make sure the room unit was charged sufficiently prior to testing.**

Depending on receiver type and configuration, an LED indicates if the receiver finds the LEARN button was pressed on a learned room unit. No acknowledgement occurs if the telegram is not received completely. Possible causes: Distance too great or unfavorable mounting location with too many interference sources within the radio link.

Technical data

| | | Type | QAX95.4 | QAX96.4 | QAX97.4 | QAX98.4 |
|------------------------------------|--|----------------|--|-------------------------------------|-------------------------------------|---------|
| Design | Room temperature | | All | | | |
| | Setpoint adjustment | | <input checked="" type="checkbox"/> | <input checked="" type="checkbox"/> | <input checked="" type="checkbox"/> | |
| | Selector switch | | | <input checked="" type="checkbox"/> | <input checked="" type="checkbox"/> | |
| Powered by solar cell | Solar cell, buffering by capacitor up to 4 days | | All | | | |
| Powered by battery | Battery operation possible at very unfavorable lighting conditions (CR2032, battery life > 5 years) | | All | | | |
| Measuring range | 0...40 °C | | All | | | |
| Measuring accuracy | ± 0.4 K (18...26 °C) | | All | | | |
| Setpoint correction) | Range is set at receiver / gateway | | All | | | |
| Output | HF sender (EnOcean) | | All | | | |
| EnOcean Equipment Profile | EEP 07-10-01 | | All | | | |
| Transmitting frequency | 868.3 MHz (Adhere to local and current legislation) | | All | | | |
| Transmitting power: | <= 10 mW (Adhere to local and current legislation) | | All | | | |
| Frequency of data transmission | Value | Action | Sent after | | | |
| | Actual value | 0.9K | Approx.. 2 minutes | | | |
| | Setpoint | | Approx.. 2 minutes | | | |
| | Stage switch | Rotate | Approx.. 2 minutes | | | |
| | LEARN button | Press | Immediately | | | |
| | Freely-programmable button | | Immediately | | | |
| | General: A telegram is sent at the latest ca. 16 minutes after the last telegram. This is repeated periodically. | | | All | | |
| Mounting | Wall mounting | | All | | | |
| Range in buildings | Max. 30 m, see page 12 | | All | | | |
| Ambient temperature | 0...50 °C, non-condensing | | All | | | |
| Storage temperature | -20...60 °C | | All | | | |
| Protection class | III (protective extra-low voltage, as per EN 60730-1) | | All | | | |
| Degree of protection | IP30 (mounted), IP00 (unmounted) | | All | | | |
| Housing material | ASA/PC | | All | | | |
| Color | Titanium white similar to RAL 9010 | | All | | | |
| Dimensions | See "Dimensions" | | | | | |
| Weight | Including mounting plate, adhesive pad, frame | | 50 g | 52 g | 54 g | 54 g |
| | Packaging (corrugated cardboard box) | | 50 g | 50 g | 50 g | 50 g |
| Standards, directives | CE -Conformity as per | | | | | |
| | EMC directive | | 2004/108/EC | | | |
| | - Immunity | | - EN 61000-6-2 | | | |
| | - Emissions | | - EN 61000-6-3 | | | |
| | Low voltage directive (LVD) | | 2006/95/EC | | | |
| | - Electrical safety | | - EN 60730-2-9 | | | |
| Radio & Telecom. equipment (R&TTE) | | 1999/5/EC | | | | |
| - RF communication (ERM) | | - EN 300 220-2 | | | | |
| | | - EN 301 489-3 | | | | |
| Environmental compatibility | The product environmental declaration CM2E1663 contains data on environmentally compatible product design and assessments (RoHS compliance, materials composition, packaging, environmental benefit, disposal) | | ISO 14001 (environment) ISO 9001 (quality) 2002/95/EC (RoHS) | | | |

Disposal



"The device is considered electronics device for disposal in terms of European Directive 2002/96/EG (WEEE) and may not be disposed of as domestic garbage. The device must be disposed of via the proper channels. Follow all local and currently applicable laws and regulations.

Used together with third-party receivers

For detailed information, see the description of the radio signal modules available for download at: <http://www.enocean-alliance.org/en/home>.

Dimensions

Dimensions in mm

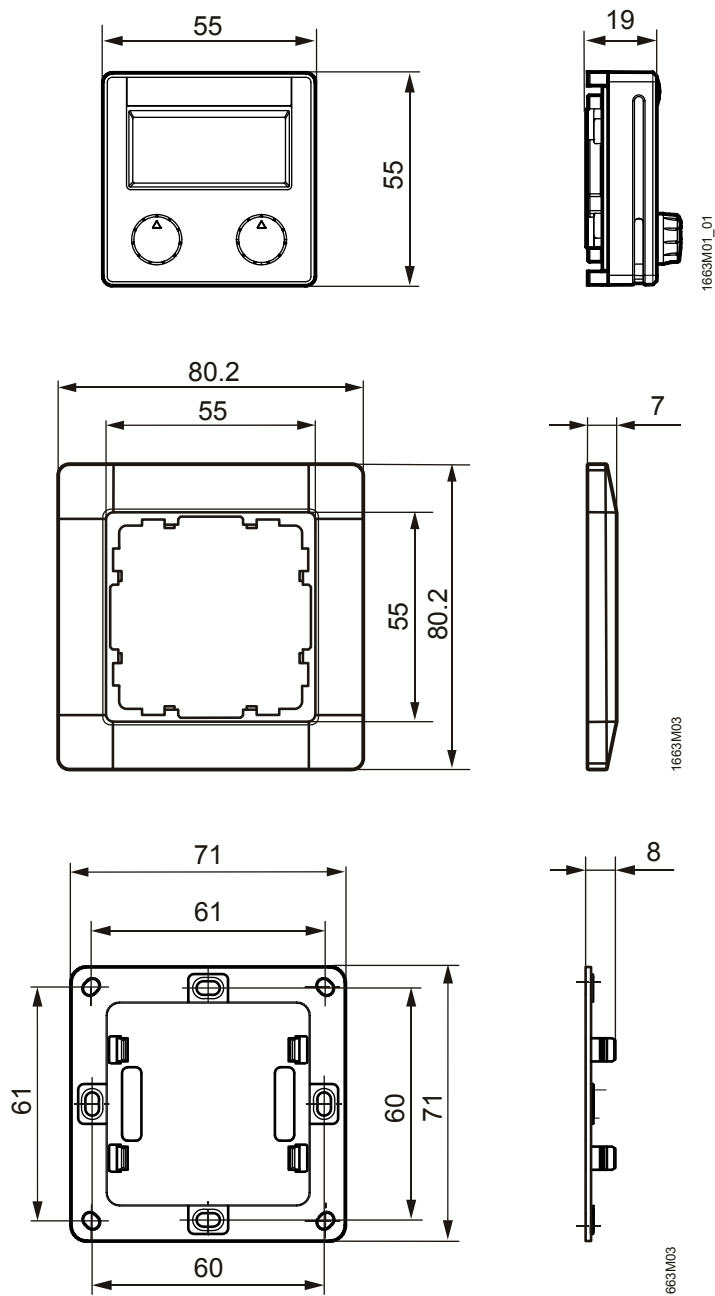

Radio signal range

A radio signal's strength decreases with distance as it is sent in all directions. In addition, other factors influence the radio signal strength.

Below are a few examples of interference and attenuating impact of different materials.

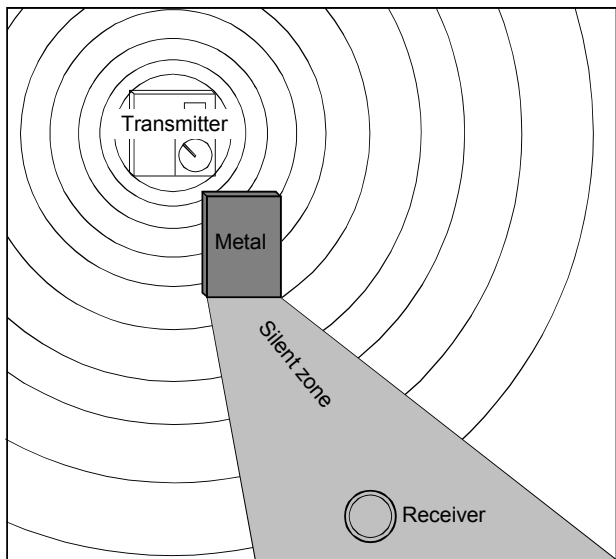

| Material: | Passage of radio signals |
|------------------------------|--------------------------|
| Wood, gypsum, uncoated glass | 90...100% |
| Brick, pressboards | 65...95% |
| Reinforced concrete | 10...90% |
| Metal, aluminum lamination | 0...10% |

Avoid under all circumstances to **metallically screen** a room unit.
At the same time, avoid **mounting** on a metallic surface.

Building materials as well as wall angles in particular influence the radio signal range with the radio link. The greater the angle at which electromagnetic waves hit a wall, the greater signal attenuation.

As a result, avoid flat angles and wall niches.

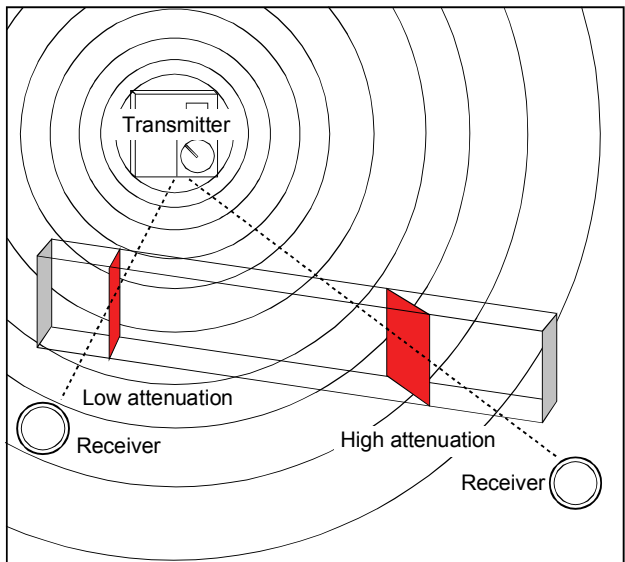

| Examples: | Radio signal range | Passage |
|--|------------------------------|--------------|
| Visual contact: | | |
| In hallways | Up to 30 m | |
| In halls | Up to 100 m | |
| RIGIPS walls, dry wood | Ca. 27 m up to 30 m | Max. 5 walls |
| Brick walls, aerated concrete | Ca. 19 m | Max. 3 walls |
| Reinforced concrete walls | Ca. 10 m | Max. 1 wall |
| Fire protection walls, elevator shafts, stairwells, supply areas | The radio signal is isolated | |

A white paper on range planning for EnOcean systems is available on the Internet. Use either a search engine to locate the white paper or go the EnOcean homepage at:

[http://www.enocean.com/fileadmin/redaktion/pdf/white_paper/WP_RANGE_PLANNING Jun09_en.pdf](http://www.enocean.com/fileadmin/redaktion/pdf/white_paper/WP_RANGE_PLANNING_Jun09_en.pdf)